

OUR LADY & ST PATRICK'S CATHOLIC NURSERY AND PRIMARY SCHOOL



Fourth Avenue, Teignmouth TQ14 9DT
Tel: 01626 773905
e-mail: office@olsp.uk

Living, Loving and Learning in God's Way



Newsletter: 15th March 2024

Executive Head Teacher: Mrs Cathy Blatchford

HEAD TEACHER UPDATE

Yet again we have had an incredibly busy couple of weeks. It is unbelievable how much we fit in. Thank you to all of the parents and carers that completed the school survey. One thing we are aware of is how long our newsletters are and would be interested to know what you as parents think we can scale back on. We want to keep you informed and would appreciate any constructive feedback you can give. If you haven't completed the questionnaire yet, please do so as we really appreciate the feedback received.

We are thrilled to welcome our family support worker, Rachel back on Wednesday and she has picked up where she left off.

Our Year 3 and 4 have been busily clocking up the miles for the Big Lent Walk and next week sees our Year 5 and 6 doing what they can walking all the way to Dawlish. Do let us know if you would like to join us. Thank you for the donations so far.

I look forward to seeing many of you at the St Patrick's disco this evening.

Have a lovely weekend.

God Bless

Mrs Cathy Blatchford
Executive Head Teacher

THE CATHOLIC LIFE OF OUR SCHOOL

Over the last couple of weeks, our brilliant Pupil Chaplains have been making decorative posters (to display at Our Lady and St Patrick's Church) for St David's Day. They have also made personalised Easter cards for the residents of the White House care home, Teignmouth. These are the same residents who did Christmas baking with the Chaplains back in December.

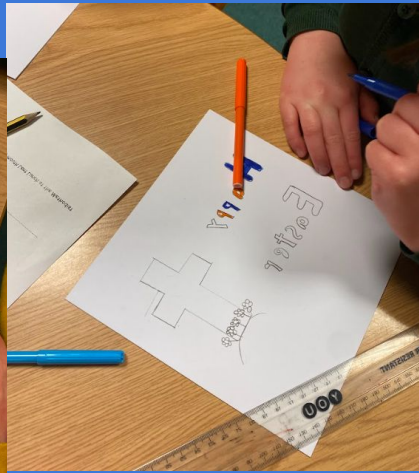
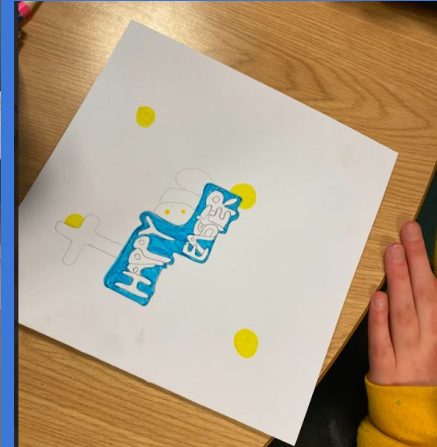

SPRING 2 TERM CLUBS:

These clubs are running this half term

Please use this link to sign your child up

https://docs.google.com/forms/d/e/1FAIpQLSd-88w7mIMT6TVxRj6x2D5LGH8A5LJnboMFleJnCyZrKq2Vrw/viewform?usp=sf_link



- Spanish with Dani Wednesdays 3.15pm - 4pm
- Multi-Sports Wednesdays 3.15pm - 4.15pm (Year 1/2/3 only)
- Year 3/4 Gardening Club Fridays 3.15pm - 4pm (First-come, first-served as places are limited)
- Maths SATS booster club (Year 6). Thursday 3.15pm-4pm.
- Lacrosse - Premier Sport Fridays 3:15 - 4:30pm



You are invited...



to Premier Education's extracurricular activities!

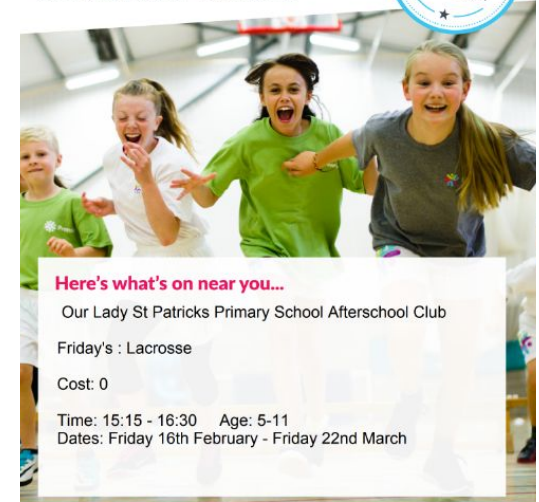

Here's what's on near you...

Our Lady St Patricks Primary School Afterschool Club

Friday's : Lacrosse

Cost: 0

Time: 15:15 - 16:30 Age: 5-11

Dates: Friday 16th February - Friday 22nd March

To discover the activities available and to book today, visit premier-education.com

EARLY YEARS



The children loved celebrating World book day with all their friends. It was lovely to see all their amazing costumes.

YEAR 1 & 2

We had a fantastic time in Mars class on World Book Day! We loved dressing as characters from books and asking our friends to guess who we were. Playing the masked reader was fun, but tricky as some of the adults changed their voices! We also enjoyed decorating our door with some of our favourite books, including Matilda which is our class read.

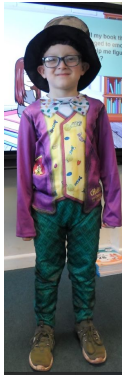

YEAR 3

The year 3's this week have been looking at the history of robots in STEM. Looking at how they have developed over time and become more advanced in their programming and design.

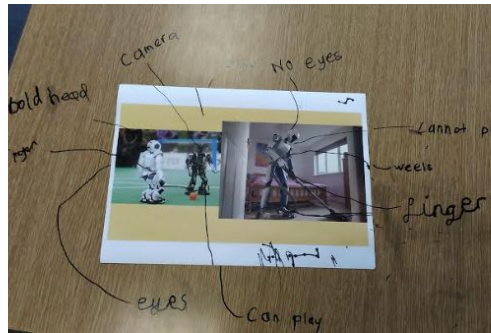

YEAR 4

Class 4 have been incredibly busy over the past couple of weeks and have participated in lots of different activities. The children were all very passionate in dressing up as different book characters for World Book day and sharing their books with each other.

Additionally, the children had great fun at the TCS football festival participating in different invasion games and friendly competitive matches. The children showed resilience and a great attitude at giving it a go.



YEAR 5

On World Book Day, OLSP held a door decorating competition. We decorated ours with a 'Coraline' theme as that's our class book.



We won!
Well done
year 5
Awesome
work.

YEAR 6

World book day! The children all loved dressing up! Part of the day, Class 6 created a door to showcase their learning of 'Kick', the book they are learning about in their reading lessons.



DISCIPLE OF THE WEEK

	04.03.24	11.03.24
	Faith	Charity
Early Years	Rune	Henry L
Y1 & Y2	Theo	Arthur T
Y3	Dorothy	Di-anne
Y4	Iris	Ava
Y5	Billie-Jo	Paris
Y6	Nama	Lucas

STAR OF THE WEEK

	04.03.24	11.03.24
Early Years	Lumen	Gypsy-Leigh
Y1 & 2	Nela	Oliver
Y3	Max	Estrella
Y4	Caitlyn	Darcey F
Y5	Sebastian	George
Y6	Gracie	Clarke



YEAR 4 - FOOTBALL FESTIVAL AT TCS

Saturn Class participated in a Year 4 football festival, learning different football skills through invasion games as well as taking part in competitive friendlies against each other and other schools. A massive thank you to Zoe and Teresa who were able to help walk the children there and back.



4th - 15th March	
Reception	92.29%
Year 1/2	98.62%
Year 3	96.76%
Year 4	97.99%
Year 5	92.33%
Year 6	85.24%

Well done to Mars once again !

Is your child too poorly for School?

If you are unsure about your child's symptoms and whether to send them to school, the following link is very informative

https://www.nhs.uk/live-well/is-my-child-too-ill-for-school/?utm_medium=email&utm_source=govdelivery

A Message from Steph, our Attendance and Welfare Officer

Illness

Just a reminder that if your child is not going to be in school due to illness, please contact the school by 9.30am by leaving a message on the absence line or emailing the school office.

Please provide a specific reason for absence and ensure that you call the school every day that your child will not be attending.

If we do not have contact from you, the office will call all other phone numbers and a member of staff may visit your home. The absence will be unauthorised.

Days off school add up to lost learning

175 NON SCHOOL DAYS A YEAR 175 days to spend on family time, visits, holidays, shopping, household jobs and other appointments					
190 SCHOOL DAYS IN EACH YEAR 190 days for your child's education	10 days absence 180 Days of Education	19 days absence 171 Days of Education	29 days absence A term missed 161 Days of Education	38 days absence 152 Days of Education	47 days absence 143 Days of Education
100%	95%	90%	85%	80%	75%
Good Best chance of success. Gets your child off to a flying start		Worrying Less chance of success. Makes it harder to make progress		Serious Concern Not fair on your child. Court action!	



Diary Dates

15th March	10am Mass for St Patrick in School 5pm - 7.15pm Friends St Patrick's Day Party	WB 13th May	SATS week for Year 6
17th March	St Patrick's Day	16th May	School dinner Mexican theme day "Fiesta Fun" (Menu change - details will be sent nearer the time)
26th March	4:30pm Year 5/6 Dawlish Water Rotary Club Primary Schools Quiz Challenge	19th May	Pentecost
28th March	Last day of Spring Term Friends Easter Non-Uniform and Easter Bonnet Competition Fire safety talks for Years 1/2 and 5	27th May	Half Term Holiday
15th April	Summer Term Starts	3rd June	INSET Day (Non-Pupil)
15th - 19th April	Y6 Residential	4th July	Year 1/2 attending Mass at Shaldon Church
23rd April	St George's Day School dinner theme day (Menu change - details will be sent nearer the time)	5th July	2pm - 3pm Whole School Music Celebration (more info to follow nearer the date)
6th May	May Day bank holiday	19th July	3.30pm - 8.30pm School Barbecue
7th May	10am Mass for Pentecost in School	24th July	9am End of Year Mass
9th May	Year 3 attending Mass at Shaldon Church Ascension Day	25th July	Last day of Summer Term

Friends News!

The Easter season brings with it a sense of joy and creativity, and what better way to celebrate than with a fun-filled bonnet competition? We invite all children to participate in this event, where they'll have the opportunity to showcase their artistic talents and creativity.

Each child will be provided with a bonnet to assemble and decorate. These bonnets will be distributed to the students in the coming days.

All decorated bonnets must be returned to the school no later than Thursday 28th March. There will be a first, second and third prize for each class.

Let's make this Easter Bonnet Competition a memorable and enjoyable experience for our children!

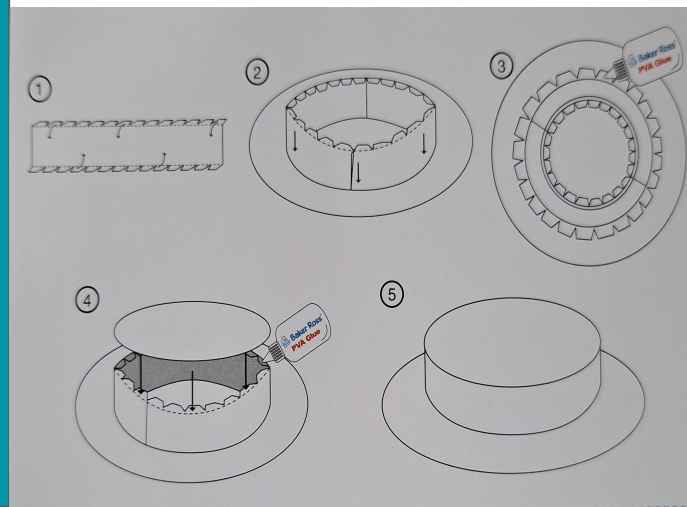

"So please, oh please, we beg, we pray, go throw your TV set away, and in its place you can install a lovely bookshelf on the wall." - Roald Dahl



JOIN PIP, ZENA AND LIBRO
ON THEIR NEW ONLINE ADVENTURE

The Secret Book Quest digital platform is quick and easy to sign up to online, where you can join Zena, Pip and Libro the cat on an exciting reading adventure. Signing up online will unlock access to The Secret Book Quest story, online games and downloadable activities!

To carry on your quest and unlock the next zone, visit your local library. As a library member, a child can sign up to receive their **free** pack, including stickers to collect along the way, puzzles to solve, certificates and a finisher's prize too.

Head to www.tsbq.co.uk
or your local library to begin your adventure!

THIS NEWSLETTER WE RECOMMEND

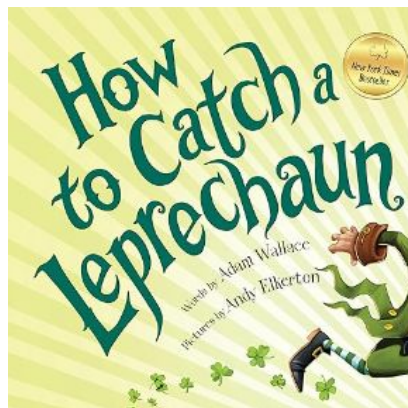

How to catch a Leprechaun by Adam Wallace

Celebrate St. Patrick's Day with this laugh-out-loud adventure! You've been planning night and day, and finally you've created the perfect trap with shamrocks, pots of gold, and rainbows galore! Now all you need to do is wait. Is this the year you'll finally catch the leprechaun? Start a St. Patrick's Day tradition with this fun and lively children's book and get inspired to build leprechaun traps of your own at home! Laugh along in this zany story for kids with hilarious rhymes and vibrant illustrations!

How to catch a leprechaun?

It's tougher than you think!

He'll turn your whole house upside down.

He's quicker than a wink!

I Don't Like Books. Never. Ever. The End. By Emma Perry

Once upon a time there was a girl called Mabel. A girl who didn't like books. She used them for all sorts of things, from juggling to sledging, but she never looked at the stories inside. Until the books decided they had had ENOUGH!

Tossed one night into the books' pages, hopping between adventures, Mabel finally discovers what she's been missing . . .

This was the book Mrs Blatchford read to the whole school on World Book Day!

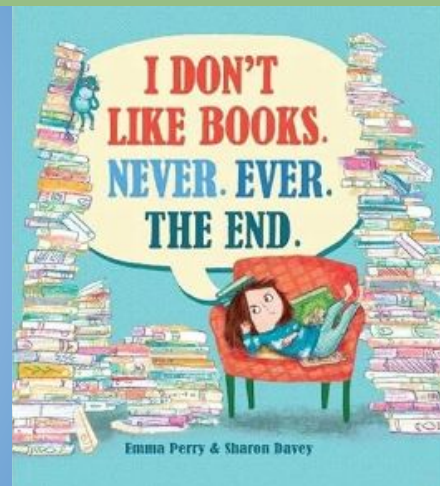



Safe, active, together.



Multi-activity Holiday Camps for your children!

Our Holiday Camps have been making kids happy for over 20 years, and this Easter should be no different. Our super-fun sessions are jam-packed with safe activities for every child to enjoy.

To book now, visit
premier-education.com/holiday-camps

Follow our socials @PremEducationUK



Our Holiday Camps near you...

Venue: Our Lady and St Patricks Primary School

Dates: 2nd April - 12th April

Times: 09:00AM - 15:30PM

Price: £20.02

Ages: 5 - 12 year olds

Additional Info:

Please visit our website to book your child's place www.premier-education.com/parent-search Our lady and St Patricks

Taking every precaution

Our Activity Professionals have been undergoing additional training in order to provide the best care to the children under their supervision, specifically the Transcend Level 2 Award in Infection Prevention, Mitigation and Management.

They will need

- A packed lunch
- Plenty of water
- Suitable clothing for the weather
- Loads of energy!

Premier Education Promise: In the event these courses are cancelled, we will issue a full refund within 7 days.



TEIGNMOUTH SCOUT GROUP

TEIGNMOUTH RABBIT RUN

EASTER MONDAY

FUN RUN STARTS AT 11 AM
AT TEIGNMOUTH PIER

FULL DISTANCE
1.5 MILES (APPROX)

MEDALS FOR
ALL FINISHERS

ADULTS £7
CHILDREN £5
FAMILY £20 (2+2 OR 1+3)
YOUTH MEMBERS £4.50



Scouts
4th Teignmouth
Scout Group

TEIGNMOUTH YOUTH CHOIR SPRING CONCERT



TICKETS

ADULTS - £5
UNDER 16'S - FREE

TICKETS ON DOOR
OR EMAIL

TEIGNMOUTHCHOIR@GMAIL.COM

SATURDAY 16TH MARCH
7PM
ST PETER'S CHURCH
SHALDON

TEIGNMOUTH YOUTH CHOIR

Age 7 -16
years.

Join the
Teignmouth Youth Choir

Monday afternoons in term time
3.45 - 4.30pm @ The Alice Cross Centre
First session free!
£15 per half term thereafter

Email for further details: teignmouthyouthchoir@gmail.com
Find us on Facebook: www.facebook.com/teignmouthyouthchoir



Family Events Spring 2024



Peppa Pig Cinema Party!



Come on everybody it's time for Peppa's Cinema Party! This year Peppa Pig celebrates her 20th anniversary and to mark it- the **MOST EPIC PARTY EVER.**

Friday 16th February 11.00am & 2.00pm
£7.00 Adult, £5.00 child

Craft Workshops



Make your own model of the Owl and the Pussycat in their iconic Pea-Green boat. Or make a mask of your favourite woodland animal.

Monday 12th February &
Monday 8th April.
10.30am-12.30pm
£15.00 per child
see website for further details

Disney's Wish

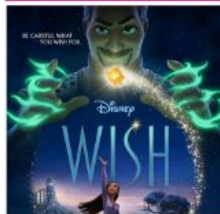

Young Asha makes a wish so powerful that it's answered by a cosmic force, a little ball of boundless energy called Star

Monday 12th February
11.00am & 2.00pm
Adults: £7.00 Children: £5.00

BOX OFFICE 01626 249049
www.pavilionsteignmouth.org.uk

Family Theatre Spring 2024



Sam O'Shanty



A nautically comic show for all the family, crammed with Fact - Farce & Fantasy, in which storytelling, Puppetry & the singing of shanties will entertain, enthral & delight..... **HUZZAR!**

Saturday 2nd March, 2.00pm
£8.00 Adult, £10.00 child

The Witch & The Egg



Witch does what witches do best... fly around scaring people and eating biscuits. The last thing she wants in her life is an **EGG!**

Should she have it for breakfast or hatch it? This show is an adaptation of the book 'The Witch's Egg' by Madeleine Edmondson.

Wednesday 14th February, 2.00pm
£8.00 Adult, £10.00 child

Laura Wall's Goose



This forty five minute interactive production brings Teignmouth's very own Laura Wall's laugh out loud illustrations and loveable characters to life. 'Goose' is an instant favourite with young and old.

Saturday 30th March 1.00pm & 3.00pm
all tickets £12.00

BOX OFFICE 01626 249049
www.pavilionsteignmouth.org.uk

DIGGERLAND

Buckets Of Fun For Everyone!



20% OFF

AT ANY DIGGERLAND UK PARK

Office Use Code: 92338

Expiry Date: 03/11/2024

Not valid during July and August

Terms: www.diggerland.com/voucher-terms

📍 www.diggerland.com ☎ 01634 711711 ✉ marketing@diggerland.com

**Exclusive offer for Our Lady and
St Patrick's Primary School**



Present voucher on arrival at any Diggerland park (Kent, Devon, Durham, Yorkshire). Max 4 people.

NOT VALID WITH ONLINE BOOKINGS

School Website Free App

Parents and Carers have access to a free app, linking you to our School Website. If you download the app, you will receive a notification every time information is added or updated on our website. This is a very useful tool that we are hoping as many Parents and Carers will make use of as possible. Please use the qr code below to access the download. Or search for “eSchools Lite” in the **App Store**

(**Apple**) or **Google Play (Android)**



Free behaviour support resources for schools and families

Have you heard of **My Family Coach**? It's an incredible free platform for schools and families for help and support with all areas of behaviour, school and family life.

The platform includes **over 50 hours of free support content** from the experienced team here at Team Teach. There's **articles, podcasts, videos, ebooks and quarterly online parent classes** that you and the families you support can attend and watch on-demand as well.

The resources and support cover a huge variety of topics and we're always adding more: Relationships, Communication, Mental wellbeing, Friendships, Bullying, Calming down, School life, Healthy living, At risk behaviour, Screen time.

And for this time of year, families might find articles on **understanding behaviour, managing changes to routines, how to enjoy a family Christmas, using family support for childcare in the holidays, supporting your child through the holidays** or **why self care isn't selfish** helpful.

It's all available 24/7 and completely free! To access the platform as a parent or a school, simply visit the **My Family Coach website** and create an account.

Are you missing out?

More money for your school!



Nutritious meal every day!



Access to free holiday clubs!



More teachers, trips, and activities!



Check your eligibility today for Free School Meals

https://oneonline.devon.gov.uk/CCSCitizenPortal_LIVE



SAFEGUARDING

Safeguarding at OLSP is always a priority. Should you have any enquiries or concerns, please contact our Designated Senior Lead for Child Protection: Miss Wathen, or Deputies: Mrs Blatchford or Mrs Emmerton on 01626 773905 Our named governor for child protection is Mrs Lorraine Coulter

WELFARE

Our Family Support Worker is Rachel Ripley. Please let us know if you would like her to contact you for ANY support. Everyone needs a Rachel in their lives!

ATTENDANCE

Hi, my name is Steph, I'm the new Attendance and Welfare Officer here at OLSP. I will be monitoring attendance regularly to ensure that, where possible, every child is in school on time every day. If you have any concerns around your child's attendance, please leave a message with the office and I will contact you.



CPOMS and Operation encompass

At OLSP we use CPOMs as our system for recording information that we consider to be safeguarding information. As a parent you are entitled to see this information and may request to do so.

Further information about the programme can be found [here](#) -

<https://www.cpoms.co.uk/privacy-statement/>

Operation Encompass is the reporting to schools, prior to the start of the next school day, when a child or young person has exposed to, or involved in, any domestic incident.

Operation Encompass will ensure that a member of the school staff, known as a Key Adult, is trained to allow them to liaise with the police and to use the information that has been shared, in confidence, while ensuring that the school is able to make provision for possible difficulties experienced by children, or their families, who have been involved in, or exposed to, a domestic abuse incident.